

Pos. Nr. Pos.no.	Beschreibung Description	Art.-Nr. Art.no.	Preisgruppe Price bracket
421605	DB BR 236	=	
421685		=	🔊
391685		~	🔊
1	Brückenstecker mit Kondensator Connector with capacitor	66401400	6
2	Lokpfeife Loco whistle	19463400	6
3	Lokführer Loco driver	154216011	6
4	GF-Schraube M2x8 mm Self-tapping screw Mx8 mm	70900016	3
5	Motor mit Schwungrad Motor with flywheel	50421601	27
6	Windabweiser Wind deflector	12421601	5
7	Heizer Fireman	154216012	6
8	Platine kpl. m.LED-Platinen PCB ass. w. LED-PCB	65418200	28
9	Führerhaus kpl. Driver's cab ass.	11421605	18
10	Vorbau kpl. Body ass.	10421605	20
11	Glocke Bell	19450500	4
12	TS-Fenster Part set window	14421601	9
13	Rohrleitung links und rechts Pipe left and right	19503200	9
14	TS-Lampen und Lampenhalter Part set lamps and lamp holder	19492300	10
15	Türgriffstange lackiert Door handle painted	19492400	5
16	Inneneinrichtung Interior fittings	154216031	6
17	TS-Linsen Part set lenses	13421601	6
18	Leiter mit Schutzblech Ladder with mudguard	19503100	4
19	Typhon Tyfon	19463500	3
20	Handrad Handwheel	19504200	3
21	Modulhalter Module support	68401600	22
<b>Sound</b>			
22	Sounddecoder Sound-decoder	68421683	39
23	Lautsprecher Loudspeaker	68400400	16
24	Platine kpl. m.LED-Platinen PCB ass. w. LED-PCB	65418600	22
<b>AC-Wechselstrom</b>			
25	Platine kpl. m.LED-Platinen PCB ass. w. LED-PCB	65419800	25

Änderungen in Konstruktion und Ausführung vorbehalten  
We reserve the right to change the construction and specification

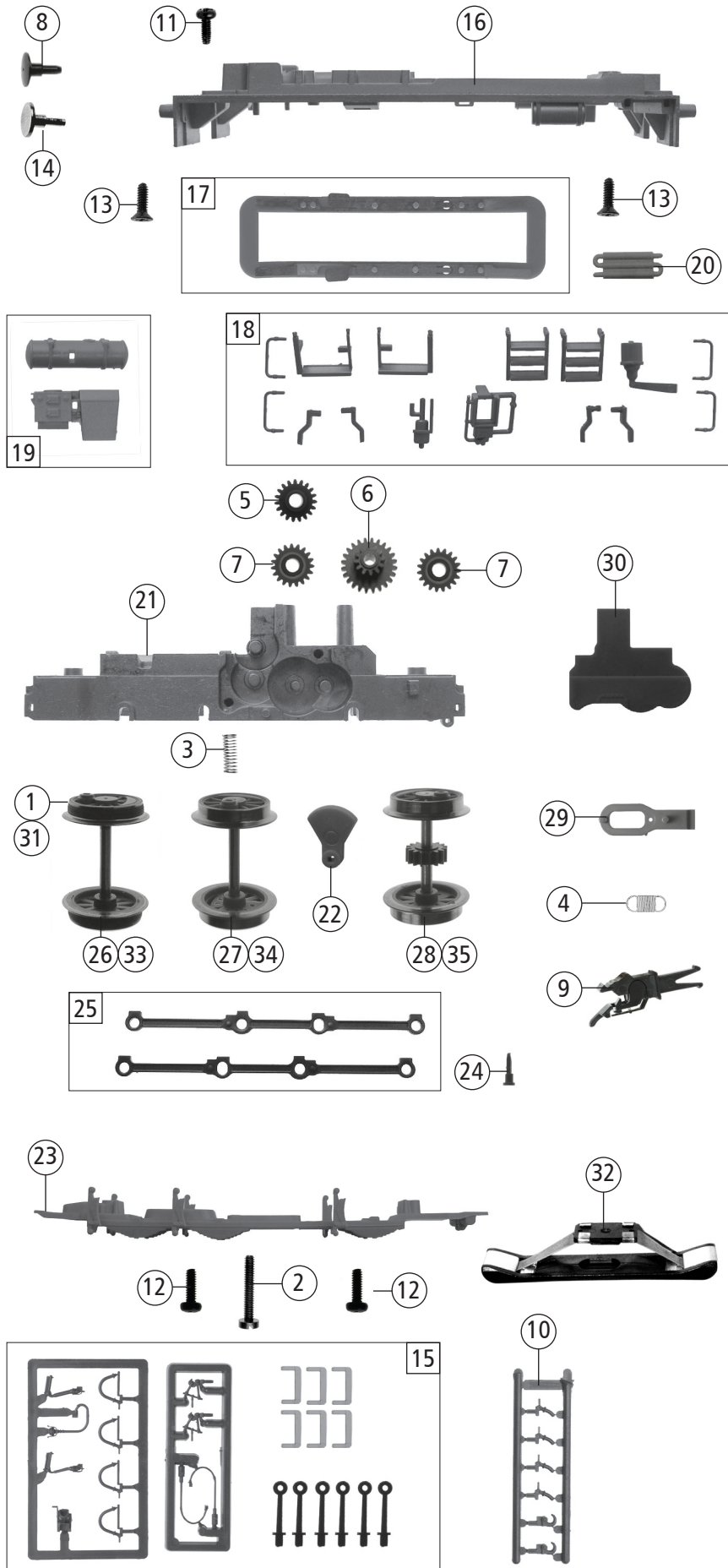

Pos. Nr. Pos.no.	Beschreibung Description	Art.-Nr. Art.no.	Preisgruppe Price bracket
421605	DB BR 236	=	
421685		=	🔊
391685		~	🔊
1	Haftringsatz 10Stk. 12,5-13,8mm Set w. traction tyres 10pieces	54401500	2
2	Schraube M1,6x10 mm Screw M1,6x10 mm	70900025	3
3	Druckfeder Pressure spring	76433700	3
4	Zugfeder Draw spring	76411700	3
5	Zahnrad Z=19/14 M=0,4 Gear wheel Z=19/14 M=0,4	56420100	4
6	Zahnrad Z=24/12 Gear wheel Z=24/12	56420200	4
7	Zahnrad Z=19/0,4 G Gear wheel Z=19/0,4 G	56420300	3
8	Puffer rund gewölbt Buffer round curved	75406900	5
9	Steckkupplung Clip-in coupling	6515	---
10	Attrappenrahmen klein Small dummy frame	19501100	4
11	GF-Schraube M2x5 mm Self-tapping screw M2x5 mm	70900026	3
12	GF-Schraube M1,6x5 mm Self-tapping screw M1,6x5 mm	70900027	3
13	SK-Schraube M1,6x5 SK-Screw M1,6x5	70900028	4
14	Puffer rund flach Buffer round flat	75407000	5
15	Zurüstbeutel Bag with accessories	194216022	13
16	Umlauf lackiert und bedruckt Running board painted and printed	15421605	18
17	Kontaktrahmen kpl. Contact frame ass.	604216022	15
18	TS-Umlauf Part set running board	19502800	7
19	Dofa Ofen und Tank groß lang links Dofa oven and tank big long left	19503000	6
20	Kühlschlange Cooling coil	19502900	4
21	Grundrahmen Basic frame	114216022	16
22	Blindwelle Jackshaft	51490500	9
23	Lokboden Loco bottom	434216022	15
24	Kuppelbolzen Coupling bolt	73059200	5
25	Kuppelstangen links und rechts Coupling rod left and right	32421601	11
26	Radsatz m. Haftring o. Zahnrad Wheelset w. traction tyre w/o gear wheel	53431700	11
27	Radsatz o. Haftring o. Zahnrad Wheelset w/o tract. tyre and gear wheel	53431800	9
28	Radsatz m. Zahnrad o. Haftring Wheelset w. gear wheel w/o traction tyre	53431900	11
29	Kupplungskammer Coupling reception	38601400	4
30	Getriebedeckel Gear cover	454216022	6
<b>AC-Wechselstrom</b>			
31	Haftringsatz 10Stk. 10,3 - 12,4mm Set w. traction tyres 10pieces	54401400	1
32	Schleifer 42mm Center pick-up 42mm	69203000	14
33	Radsatz m. Haftring o. Zahnrad AC Wheelset w.traction tyre w/o gear AC	53432100	11
34	Radsatz o. Haftring o. Zahnrad AC Wheelset w/o traction tyre and gear AC	53432200	11
35	Radsatz m. Zahnrad o. Haftring AC Wheelset w. gear wheel w/o tract. tyre AC	53432300	11